

Activity 1

Lesson 3: Orthocubes

Part 1: Match the shapes to their Right View

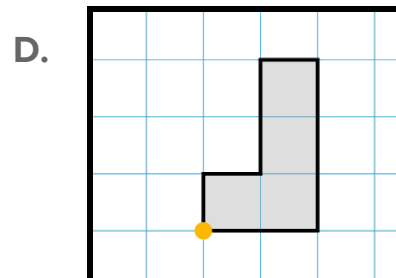
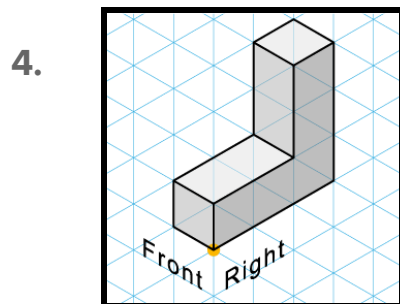
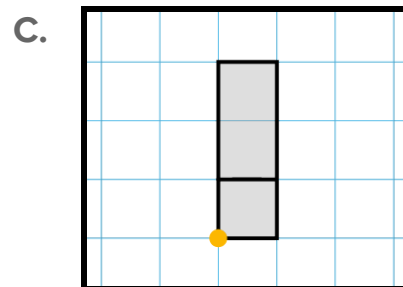
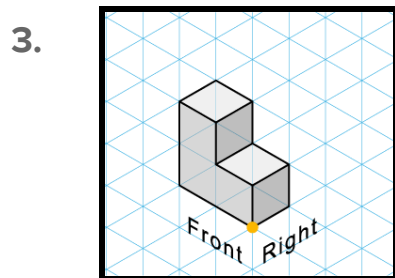
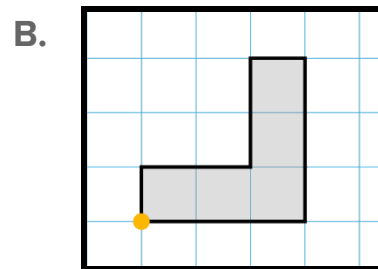
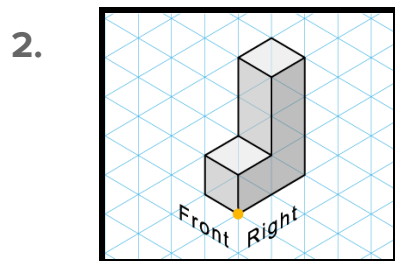
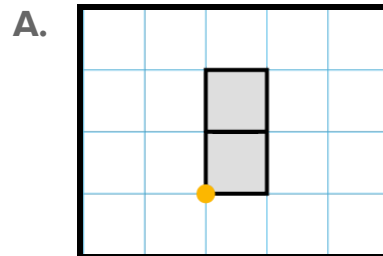
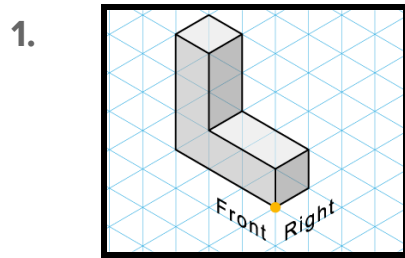

Part 2: Match the shapes to their Top View

